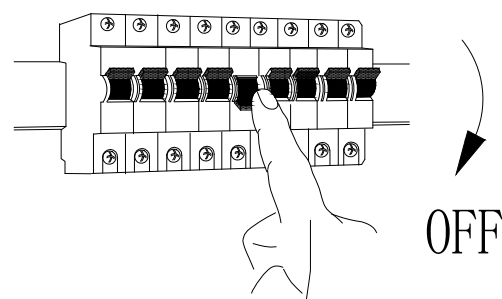
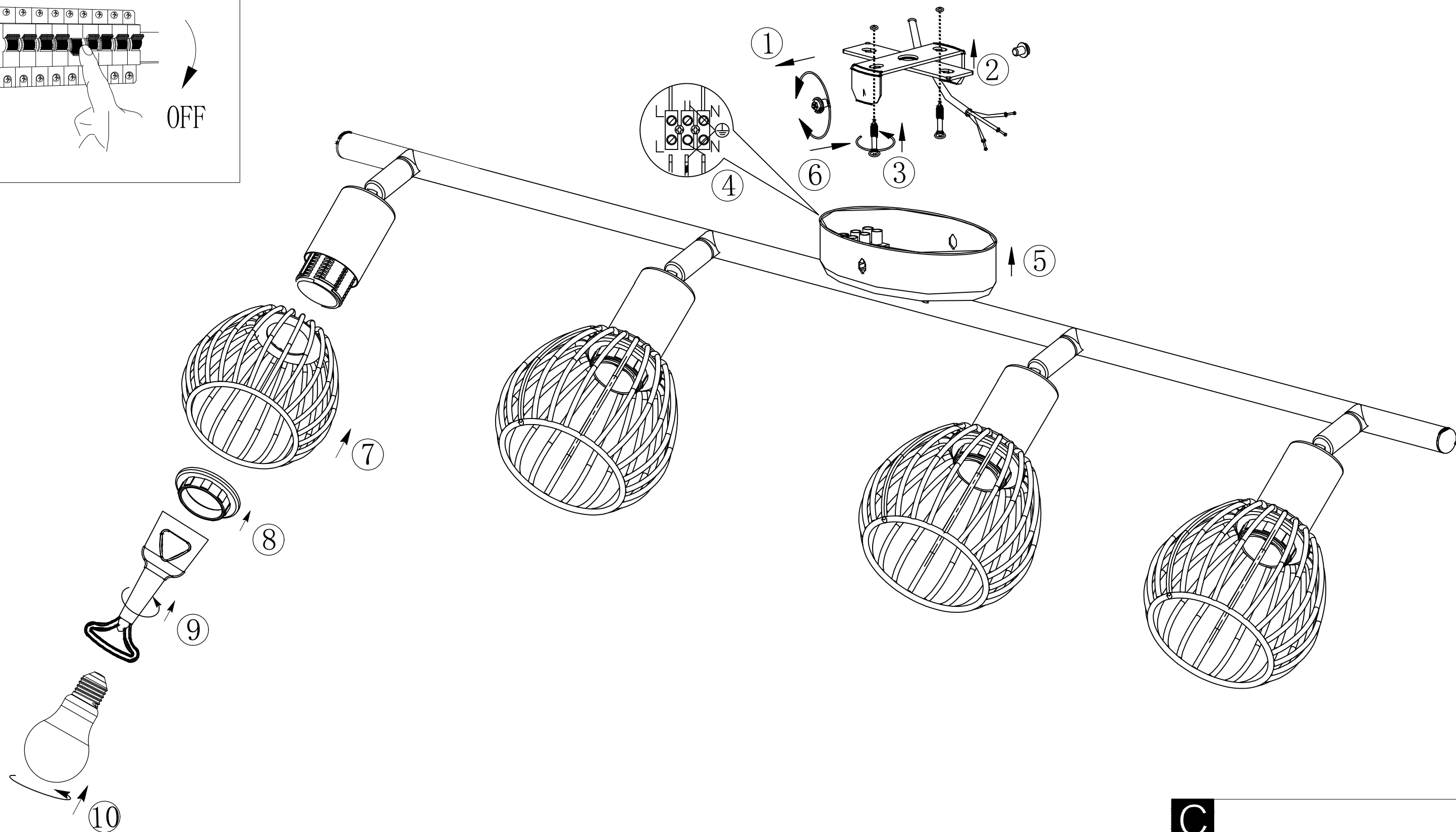
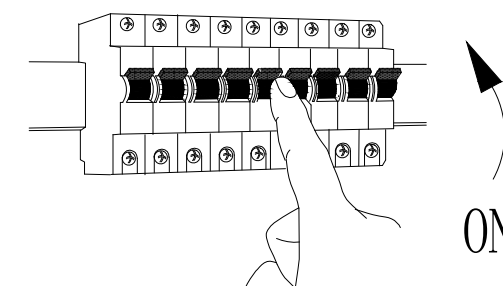

**A****B****C**

B901042  
www.eglo.com