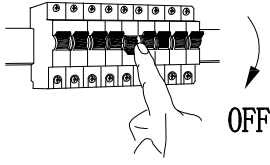
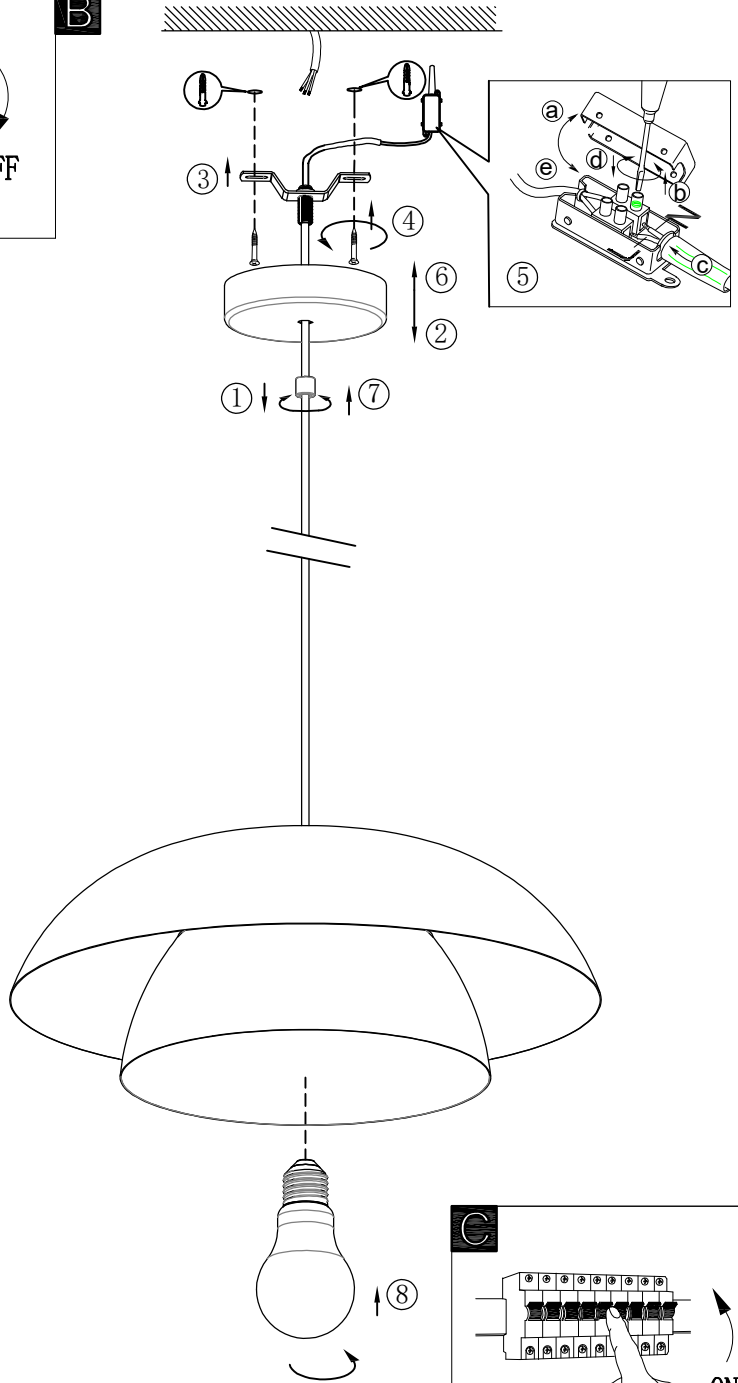
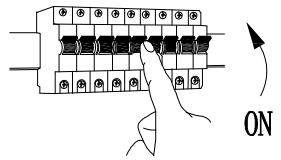

A**B****C**

B900849
www.eglo.com