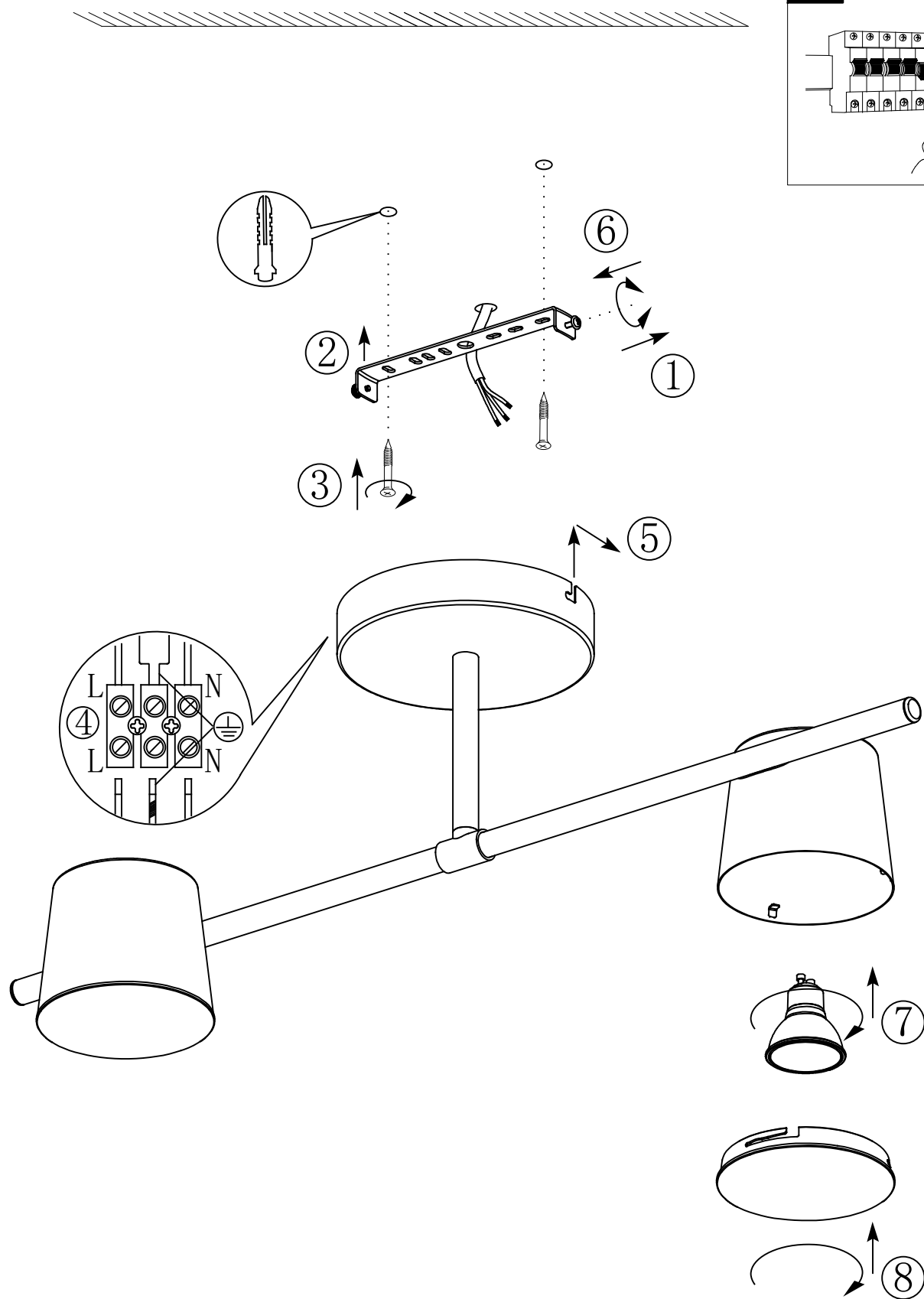
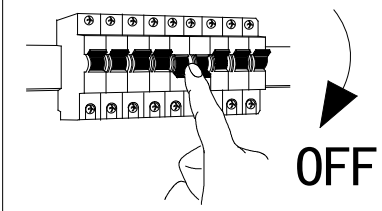
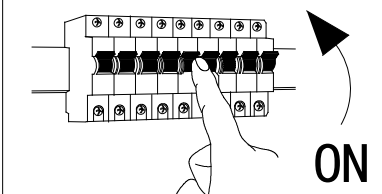

**B****A****C**

BLA39983  
 www.eglo.com